

Capacitive cylindrical type proximity sensor

■ Features

- Able to detect Iron, metal, plastic, water, stone, wood etc
- Long life cycle and High reliability
- Convenient to adjust the detecting distance by sensitivity adjustment potentiometer
- Applications to control level and position



⚠ Please read "Caution for your safety" in operation manual before using.

■ Type

○ DC 3-wire type

Appearances		Model
M18		CR18-8DN
		CR18-8DP
		CR18-8DN2 ※
M30		CR30-15DN
		CR30-15DP
		CR30-15DN2 ※

○ AC 2-wire type

Appearances		Model
M18		CR18-8AO
		CR18-8AC
M30		CR30-15AO
		CR30-15AC

▶ ※ Mark is optional.

■ Specifications

Model□	CR18-8DN CR18-8DP CR18-8DN2	CR30-15DN CR30-15DP CR30-15DN2	CR18-8AO CR18-8AC	CR30-15AO CR30-15AC
Detecting distance	8mm ±10%	15mm ±10%	8mm ±10%	15mm ±10%
Hysteresis	Max. 20% of detecting distance			
Standard detecting target	50×50×1mm (Iron)			
Setting distance	0 ~ 5.6mm	0 ~ 10.5mm	0~5.6mm	0~10.5mm
Power supply (Operating voltage)	12-24VDC (10-30VDC)		100-240VAC (85-264VAC)	
Current consumption	Max. 15mA		—	
Response frequency	50Hz		20Hz	
Residual voltage	Max. 1.5V		Max. 20V	
Affection by Temp.	±20% Max. of detecting distance at +20℃ within temperature range of -25 ~ +70℃			
Control output	200mA		5~200mA	
Insulation resistance	Min. 50MΩ (at 500VDC)			
Dielectric strength	1500VAC 50/60Hz for 1 minute			
Vibration	1mm amplitude at frequency of 10 ~ 55Hz in each of X, Y, Z directions for 2 hours			
Shock	500m/s ² (50G) X, Y, Z directions for 3 times			
Indicator□	Operation indicator (Red LED)			
Ambient temperature	-25 ~ +70℃ (at non-freezing status)			
Storage temperature	-30 ~ +80℃ (at non-freezing status)			
Ambient humidity	35 ~ 95%RH			
Protection circuit	Surge protection circuit, Reverse polarity protection		Surge protection circuit built-in	
Protection□	IP66 (IEC specification)	IP65 (IEC specification)	IP66 (IEC specification)	IP65 (IEC specification)
Weight	Approx. 72g	Approx. 212g	Approx. 63g	Approx. 220g

(A)
Counter

(B)
Timer

(C)
Temp.
controller

(D)
Power
controller

(E)
Panel
meter

(F)
Tacho/
Speed/
Pulse
meter

(G)
Display
unit

(H)
Sensor
controller

(I)
Proximity
sensor

(J)
Photo
electric
sensor

(K)
Pressure
sensor

(L)
Rotary
encoder

(M)
5-Phase
stepping
motor &
Driver &
Controller

Capacitive cyclindrical type

Dimensions

●CR18-8D□

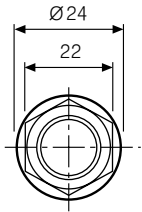

●CR18-8A□

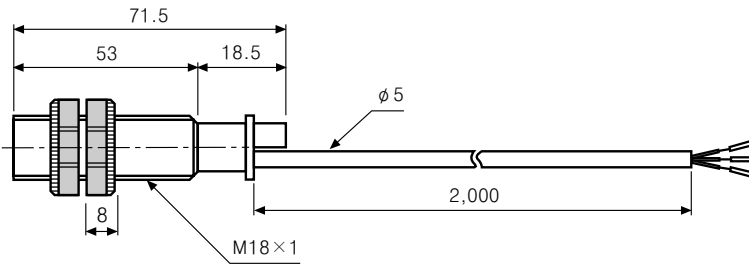

●CR30-15D□

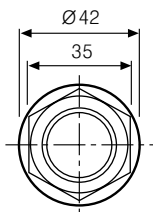

●CR30-15A□

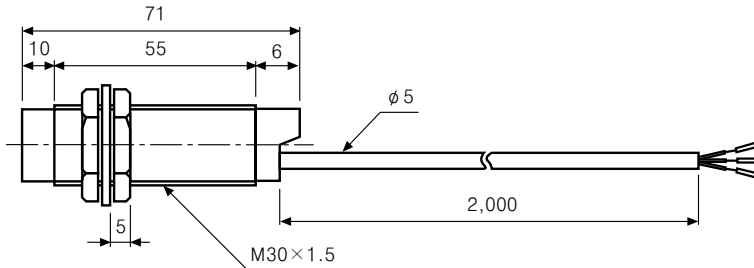

Unit:mm

Control output diagram

○DC 3-wire type

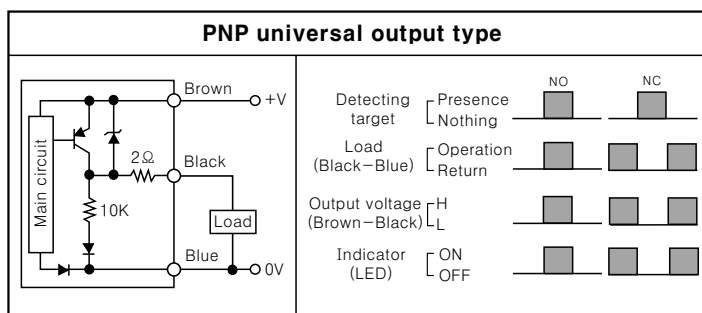
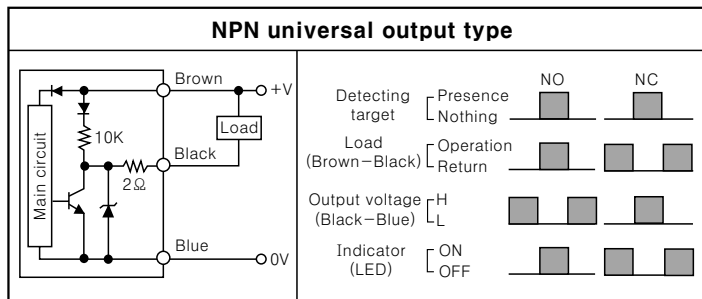

○AC 2-wire type

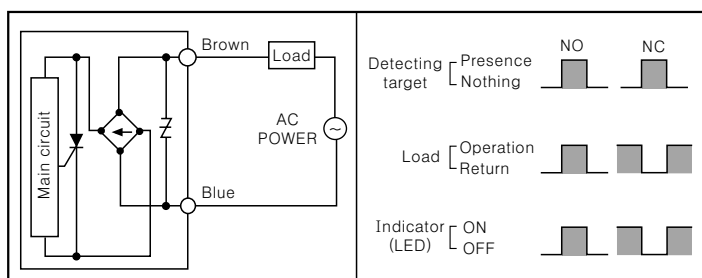

Connections

○DC 3-wire type

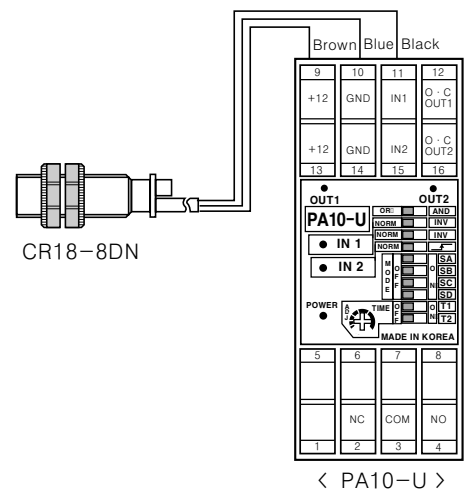

○AC 2-wire type

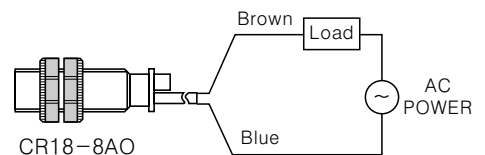

■ Sensitivity adjustment

Please turn potentiometer and sequence as below procedure.

- 1 Without any target in front of the sensing head, turn the sensitivity potentiometer clockwise until the proximity sensor turns on.
- 2 With a target in front of the sensing head, turn the sensitivity counter clock wise from the ON position stated in 1 until the proximty sensor turns off.

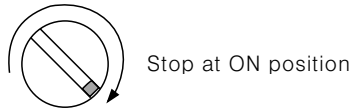

- 3 If the difference between the ON point1 and the OFF point in 2 is more that 1.5turns, the sensing operation will be stable..
- 4 If you set potentiometer at center between 1 and 2, sensitivity setting will be completed.

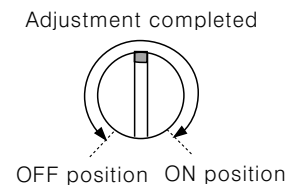
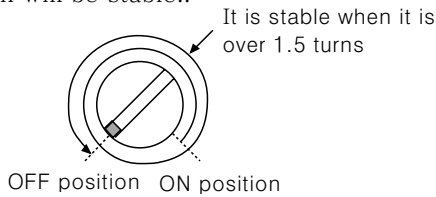

- ※ When there is distance fluctuation between proximity sensor and the target, please adjust 2 with target at farthest distance from this unit.
- ※ Turning potentiometer toward clockwise it will be Max. and turning toward counter clockwise it will be Min. number of adjustment should be 15 ± 3 revolution and if you turn on right or left excessively, it will not stop.

■ Grounding

The detecting distance will be changed by grounding status of capacitive proximity sensor and the target [50×50×1mm(Iron)]. Please check the material when install it on panel.

●CR18-

Ground condition switch b	ON	OFF
Operating distance (mm)	8	4

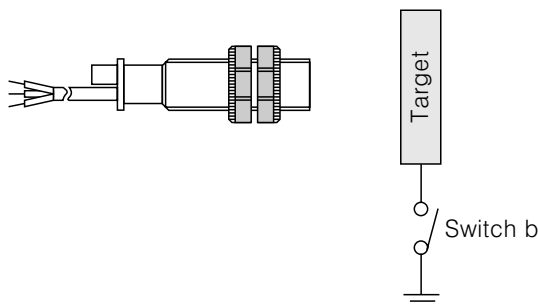

●CR30-

Ground condition	Switch a	ON	OFF	ON	OFF
	Switch b	ON	ON	OFF	OFF
Operating distance(mm)		15	18	6	6

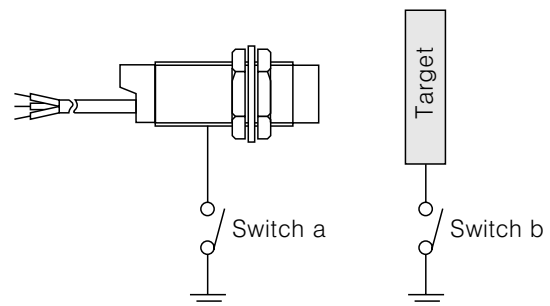

(A)
Counter

(B)
Timer

(C)
Temp.
controller

(D)
Power
controller

(E)
Panel
meter

(F)
Tacho/
Speed/
Pulse
meter

(G)
Display
unit

(H)
Sensor
controller

(I)
Proximity
sensor

(J)
Photo
electric
sensor

(K)
Pressure
sensor

(L)
Rotary
encoder

(M)
5-Phase
stepping
motor &
Driver &
Controller

Capacitive cyclindrical type

■ Mutual-interference & Influence by surrounding metals

When several proximity sensors are mounted close together, malfunction of sensor may be caused due to mutual interference. Therefore, be sure to provide a minimum distance between the two sensors, as below charts.

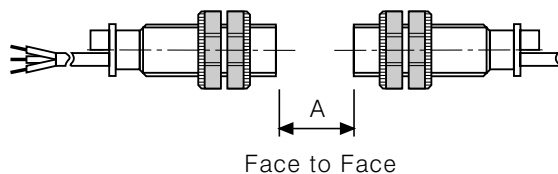

Face to Face

Model Item	CR18	CR30
A	48	90
B	54	90

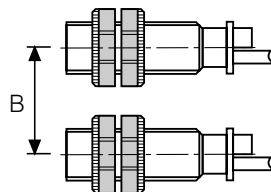

Parallel

When sensors are mounted on metallic panel, you must prevent the sensors from being affected by any metallic object except target. Therefore, provide minimum distance as shown.

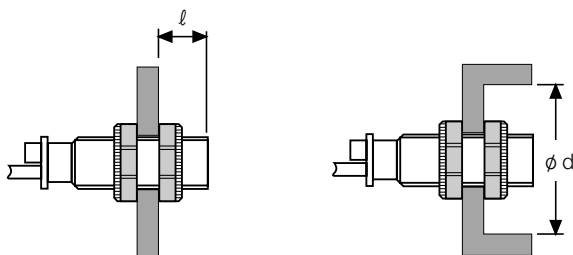

Model Item	CR18	CR30
l	20	10
ϕd	54	90
m	24	45
n	54	90

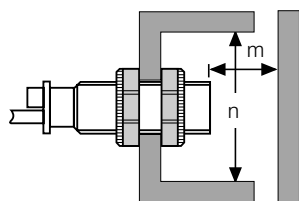

■ Materials

○ Materials of detecting targets

Detecting distance may be different by electrical characteristic of detecting target (Conductivity, Non dielectric constant) and status of water absorption, size etc.

○ Effect by high frequency electrical field

It may cause malfunction by machinery which generate high frequency electrical field such as a washing machine etc.

○ Surrounding environment

There is water or oil on surface of detecting part, it may cause malfunction.

And if the bottle for level detecting is coated by oil etc., it may cause malfunction.

Especially 15mm type has high sensitivity for induced objects, please be sure it is not coated.

○ Oils

Do not let the 18mm sensor touch oils because the case is made of plastic.