

SN74LVC2G06 Dual Inverter Buffer and Driver With Open-Drain Outputs

1 Features

- Available in the Texas Instruments Package
- Supports 5-V V_{CC} Operation
- Max t_{pd} of 3.4 ns at 3.3 V
- Low Power Consumption, 10- μ A Max I_{CC}
- ± 24 -mA Output Drive at 3.3 V
- Typical V_{OLP} (Output Ground Bounce) < 0.8 V at $V_{CC} = 3.3$ V, $T_A = 25^\circ\text{C}$
- Typical V_{OHV} (Output V_{OH} Undershoot) > 2 V at $V_{CC} = 3.3$ V, $T_A = 25^\circ\text{C}$
- Inputs and Open-Drain Outputs Accept Voltages up to 5.5 V
- I_{off} Supports Live Insertion, Partial-Power-Down Mode and Back-Drive Protection
- Latch-Up Performance Exceeds 100 mA Per JESD 78, Class II
- Supports Down-Translation (5 V to 3.3 V and 3.3 V to 1.8 V)
- ESD Protection Exceeds JESD 22
 - 2000-V Human Body Model (A114-A)
 - 200-V Machine Model (A115-A)
 - 1000-V Charged-Device Model (C101)

2 Applications

- AV Receivers
- Blu-ray Players and Home Theaters
- DVD Recorders and Players
- Desktop or Notebook PCs
- Digital Radio or Internet Radio Players
- Digital Video Cameras (DVC)
- Embedded PC
- GPS: Personal Navigation Devices
- Mobile Internet Devices
- Network Projector Front-End
- Portable Media Players
- Pro Audio Mixers
- Smoke Detectors
- Solid-State Drive (SSD): Enterprise
- High-Definition (HDTV)

3 Description

This dual inverter buffer and driver is designed for 1.65-V to 5.5-V V_{CC} operation.

The output of the SN74LVC2G06 device is an open-drain which can be connected to other open-drain outputs to implement active-low, wired-OR, or active-high wired-AND functions. The maximum sink current is 32 mA.

This device is fully specified for partial-power-down applications using I_{off} . The I_{off} circuitry disables the outputs, preventing damaging current backflow through the device when it is powered down.

NanoFree™ package technology is a major breakthrough in IC packaging concepts, using the die as the package.

Device Information⁽¹⁾

ORDER NUMBER	PACKAGE	BODY SIZE (NOM)
SN74LVC2G06DBV	SOT-23 (6)	2.90 mm x 1.60 mm
SN74LVC2G06DCK	SC70 (6)	2.00 mm x 1.25 mm
SN74LVC2G06DRY	SON (6)	1.45 mm x 1.00 mm
SN74LVC2G06DSF	SON (6)	1.00 mm x 1.00 mm
SN74LVC2G06YZP	DSBGA (6)	1.41 mm x 0.91 mm

(1) For all available packages, see the orderable addendum at the end of the data sheet.

Logic Diagram

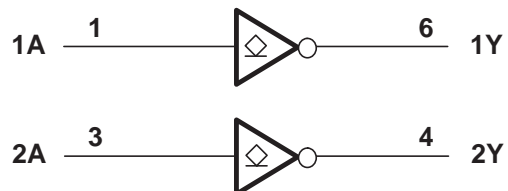

Table of Contents

<p>1 Features 1</p> <p>2 Applications 1</p> <p>3 Description 1</p> <p>4 Revision History 2</p> <p>5 Pin Configuration and Functions 3</p> <p>6 Specifications 4</p> <p style="padding-left: 20px;">6.1 Absolute Maximum Ratings 4</p> <p style="padding-left: 20px;">6.2 ESD Ratings 4</p> <p style="padding-left: 20px;">6.3 Recommended Operating Conditions 5</p> <p style="padding-left: 20px;">6.4 Thermal Information 5</p> <p style="padding-left: 20px;">6.5 Electrical Characteristics 6</p> <p style="padding-left: 20px;">6.6 Switching Characteristics for –40°C to 85°C 6</p> <p style="padding-left: 20px;">6.7 Switching Characteristics for –40°C to 125°C 6</p> <p style="padding-left: 20px;">6.8 Operating Characteristics 6</p> <p style="padding-left: 20px;">6.9 Typical Characteristics 7</p> <p>7 Parameter Measurement Information 8</p> <p>8 Detailed Description 9</p>	<p>8.1 Overview 9</p> <p>8.2 Functional Block Diagram 9</p> <p>8.3 Feature Description 9</p> <p>8.4 Device Functional Modes 9</p> <p>9 Application and Implementation 10</p> <p style="padding-left: 20px;">9.1 Application Information 10</p> <p style="padding-left: 20px;">9.2 Typical Application 10</p> <p>10 Power Supply Recommendations 11</p> <p>11 Layout 11</p> <p style="padding-left: 20px;">11.1 Layout Guidelines 11</p> <p style="padding-left: 20px;">11.2 Layout Example 11</p> <p>12 Device and Documentation Support 12</p> <p style="padding-left: 20px;">12.1 Community Resources 12</p> <p style="padding-left: 20px;">12.2 Trademarks 12</p> <p style="padding-left: 20px;">12.3 Electrostatic Discharge Caution 12</p> <p style="padding-left: 20px;">12.4 Glossary 12</p> <p>13 Mechanical, Packaging, and Orderable Information 12</p>
---	--

4 Revision History

NOTE: Page numbers for previous revisions may differ from page numbers in the current version.

Changes from Revision I (December 2013) to Revision J	Page
<ul style="list-style-type: none"> • Added <i>Device Information table</i>, <i>Pin Configuration and Functions</i> section, <i>ESD Ratings table</i>, <i>Typical Characteristics</i> section, <i>Feature Description</i> section, <i>Device Functional Modes</i>, <i>Application and Implementation</i> section, <i>Power Supply Recommendations</i> section, <i>Layout</i> section, <i>Device and Documentation Support</i> section, and <i>Mechanical, Packaging, and Orderable Information</i> section 1 	1

Changes from Revision H (August 2012) to Revision I	Page
<ul style="list-style-type: none"> • Updated document to new TI data sheet format 1 • Removed Ordering Information table 1 • Added ESD warning 1 • Updated operating temperature range 5 	5

Changes from Revision G (January 2007) to Revision H	Page
<ul style="list-style-type: none"> • Updated package views and ordering information. Added DRY & DSF packages 1 	1

5 Pin Configuration and Functions

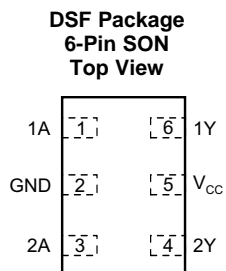
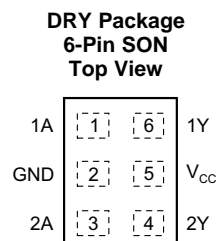
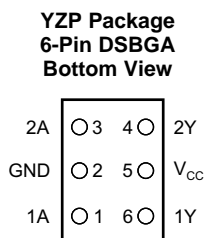
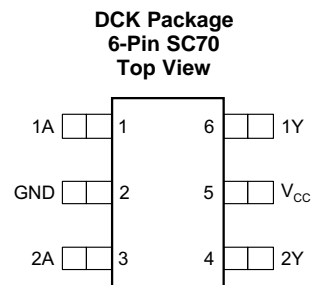
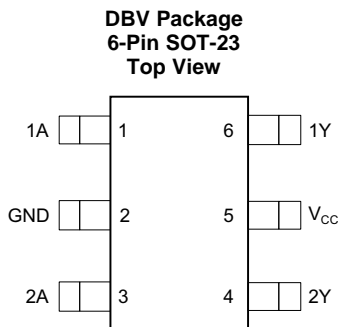

Pin Functions

PIN		I/O	DESCRIPTION
NAME	NO		
GND	2	—	Ground
1A	1	I	Input 1
2A	3	I	Input 2
1Y	6	I	Open-drain output 1
2Y	4	O	Open-drain output 2
V _{CC}	5	—	Power pin

6 Specifications

6.1 Absolute Maximum Ratings

over operating free-air temperature range (unless otherwise noted)⁽¹⁾

		MIN	MAX	UNIT
V _{CC}	Supply voltage	–0.5	6.5	V
V _I	Input voltage ⁽²⁾	–0.5	6.5	V
V _O	Voltage applied to any output in the high-impedance or power-off state ⁽²⁾	–0.5	6.5	V
V _O	Voltage applied to any output in the high or low state ⁽²⁾⁽³⁾	–0.5	6.5	V
I _{IK}	Input clamp current	V _I < 0	–50	mA
I _{OK}	Output clamp current	V _O < 0	–50	mA
I _O	Continuous output current		±50	mA
	Continuous current through V _{CC} or GND		±100	mA
T _{stg}	Storage Temperature	–65	150	°C

- (1) Stresses beyond those listed under *Absolute Maximum Ratings* may cause permanent damage to the device. These are stress ratings only, and functional operation of the device at these or any other conditions beyond those indicated under *Recommended Operating Conditions* is not implied. Exposure to absolute-maximum-rated conditions for extended periods may affect device reliability.
- (2) The input negative-voltage and output voltage ratings may be exceeded if the input and output current ratings are observed.
- (3) The value of V_{CC} is provided in the *Recommended Operating Conditions* table.

6.2 ESD Ratings

		VALUE	UNIT
V _(ESD)	Electrostatic discharge	Human body model (HBM), per ANSI/ESDA/JEDEC JS-001 ⁽¹⁾	+2000
		Charged-device model (CDM), per JEDEC specification JESD22-C101 ⁽²⁾	+1000

- (1) JEDEC document JEP155 states that 500-V HBM allows safe manufacturing with a standard ESD control process.
- (2) JEDEC document JEP157 states that 250-V CDM allows safe manufacturing with a standard ESD control process.

6.3 Recommended Operating Conditions

 over operating free-air temperature range (unless otherwise noted)⁽¹⁾

		MIN	NOM	MAX	UNIT
V _{CC}	Supply voltage	Operating	1.65	5.5	V
		Data retention only	1.5		
V _{IH}	High-level input voltage	V _{CC} = 1.65 V to 1.95 V	0.65 × V _{CC}		V
		V _{CC} = 2.3 V to 2.7 V	1.7		
		V _{CC} = 3 V to 3.6 V	2		
		V _{CC} = 4.5 V to 5.5 V	0.7 × V _{CC}		
V _{IL}	Low-level input voltage	V _{CC} = 1.65 V to 1.95 V	0.35 × V _{CC}		V
		V _{CC} = 2.3 V to 2.7 V	0.7		
		V _{CC} = 3 V to 3.6 V	0.8		
		V _{CC} = 4.5 V to 5.5 V	0.3 × V _{CC}		
V _I	Input voltage	0		5.5	V
V _O	Output voltage	0		5.5	V
I _{OL}	Low-level output current	V _{CC} = 1.65 V	4		mA
		V _{CC} = 2.3 V	8		
		V _{CC} = 3 V	16		
			24		
		V _{CC} = 4.5 V	32		
Δt/Δv	Input transition rise or fall rate	V _{CC} = 1.8 V ± 0.15 V, 2.5 V ± 0.2 V		20	ns/V
		V _{CC} = 3.3 V ± 0.3 V		10	
		V _{CC} = 5 V ± 0.5 V		5	
T _A	Operating free-air temperature	–40		125	°C

(1) All unused inputs of the device must be held at V_{CC} or GND to ensure proper device operation. Refer to the TI application report, *Implications of Slow or Floating CMOS Inputs*, [SCBA004](#).

6.4 Thermal Information

THERMAL METRIC ⁽¹⁾	SN74LVC2G06					UNIT	
	DBV (SOT-23)	DCK (SC70)	DRY (SON)	YPZ (DSBGA)	DSF (SON)		
	6 PINS	6 PINS	6 PINS	6 PINS	6 PINS		
R _{θJA}	Junction-to-ambient thermal resistance	165	259	234	123	300	°C/W

(1) For more information about traditional and new thermal metrics, see the *Semiconductor and IC Package Thermal Metrics* application report, [SPRA953](#).

6.5 Electrical Characteristics

over recommended operating free-air temperature range (unless otherwise noted)

PARAMETER	TEST CONDITIONS	V _{CC}	–40°C to 85°C			–40°C to 125°C			UNIT
			MIN	TYP ⁽¹⁾	MAX	MIN	TYP ⁽¹⁾	MAX	
V _{OL}	I _{OL} = 100 μA	1.65 V to 5.5 V			0.1			0.1	V
	I _{OL} = 4 mA	1.65 V			0.45			0.45	
	I _{OL} = 8 mA	2.3 V			0.3			0.3	
	I _{OL} = 16 mA	3 V			0.4			0.4	
	I _{OL} = 24 mA				0.55			0.55	
	I _{OL} = 32 mA	4.5 V			0.55			0.55	
I _I	A inputs	V _I = 5.5 V or GND			±5			±5	μA
I _{off}		V _I or V _O = 5.5 V			±10			±10	μA
I _{CC}		V _I = 5.5 V or GND, I _O = 0			10			10	μA
ΔI _{CC}		One input at V _{CC} – 0.6 V, Other inputs at V _{CC} or GND			500			500	μA
C _i		V _I = V _{CC} or GND			3.5			3.5	pF

 (1) All typical values are at V_{CC} = 3.3 V, T_A = 25°C.

6.6 Switching Characteristics for –40°C to 85°C

 over recommended operating free-air temperature range (unless otherwise noted) (see [Figure 3](#))

PARAMETER	FROM (INPUT)	TO (OUTPUT)	V _{CC} = 1.8 V ± 0.15 V		V _{CC} = 2.5 V ± 0.2 V		V _{CC} = 3.3 V ± 0.3 V		V _{CC} = 5 V ± 0.5 V		UNIT
			MIN	MAX	MIN	MAX	MIN	MAX	MIN	MAX	
t _{pd}	A	Y	1.8	7.2	1	3.9	1	3.4	1	2.9	ns

6.7 Switching Characteristics for –40°C to 125°C

 over recommended operating free-air temperature range (unless otherwise noted) (see [Figure 3](#))

PARAMETER	FROM (INPUT)	TO (OUTPUT)	V _{CC} = 1.8 V ± 0.15 V		V _{CC} = 2.5 V ± 0.2 V		V _{CC} = 3.3 V ± 0.3 V		V _{CC} = 5 V ± 0.5 V		UNIT
			MIN	MAX	MIN	MAX	MIN	MAX	MIN	MAX	
t _{pd}	A	Y	1.8	8.2	1	4.4	1	3.9	1	3.4	ns

6.8 Operating Characteristics

 T_A = 25°C

PARAMETER	TEST CONDITIONS	V _{CC} = 1.8 V	V _{CC} = 2.5 V	V _{CC} = 3.3 V	V _{CC} = 5 V	UNIT	
		TYP	TYP	TYP	TYP		
C _{pd}	Power dissipation capacitance	f = 10 MHz	2	2	3	4	pF

6.9 Typical Characteristics

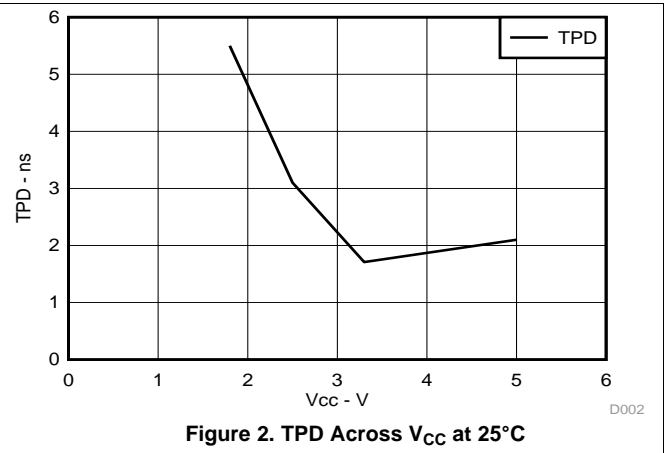
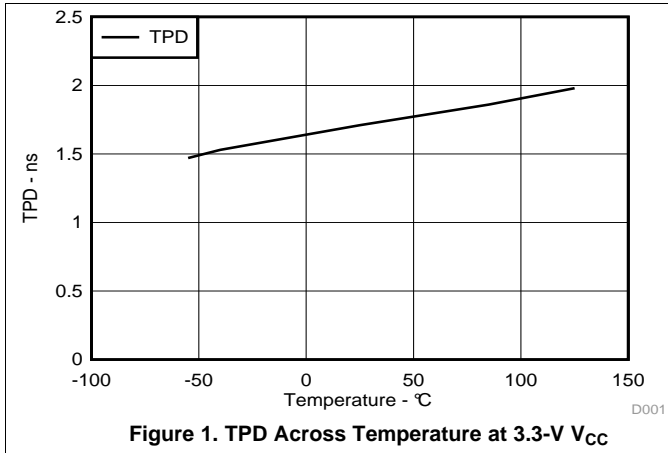

7 Parameter Measurement Information

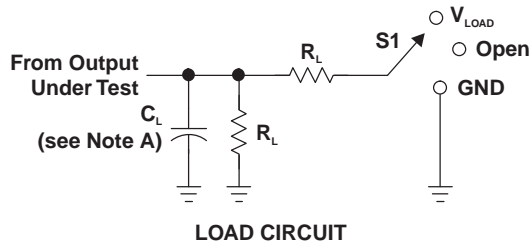

TEST	S1
t_{PZL} (see Notes E and F)	V_{LOAD}
t_{PLZ} (see Notes E and G)	V_{LOAD}
t_{PHZ}/t_{PZH}	V_{LOAD}

V_{CC}	INPUTS		V_M	V_{LOAD}	C_L	R_L	V_{Δ}
	V_I	t_r/t_f					
$1.8\text{ V} \pm 0.15\text{ V}$	V_{CC}	$\leq 2\text{ ns}$	$V_{CC}/2$	$2 \times V_{CC}$	30 pF	1 k Ω	0.15 V
$2.5\text{ V} \pm 0.2\text{ V}$	V_{CC}	$\leq 2\text{ ns}$	$V_{CC}/2$	$2 \times V_{CC}$	30 pF	500 Ω	0.15 V
$3.3\text{ V} \pm 0.3\text{ V}$	3 V	$\leq 2.5\text{ ns}$	1.5 V	6 V	50 pF	500 Ω	0.3 V
$5\text{ V} \pm 0.5\text{ V}$	V_{CC}	$\leq 2.5\text{ ns}$	$V_{CC}/2$	$2 \times V_{CC}$	50 pF	500 Ω	0.3 V

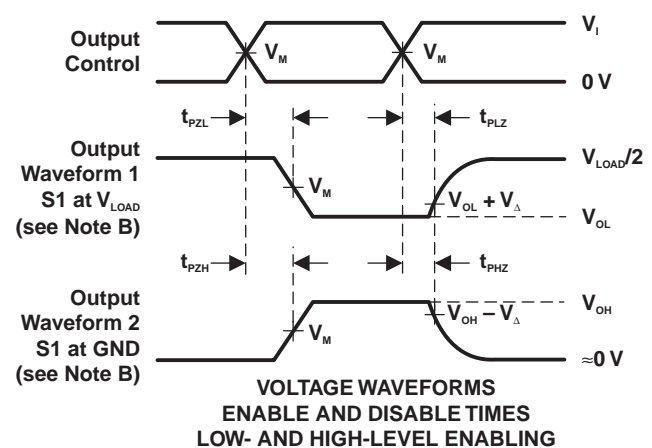
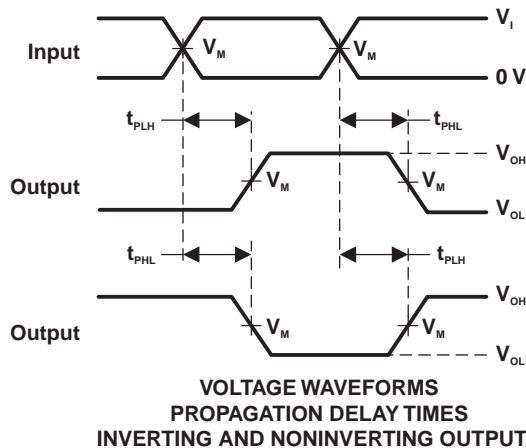
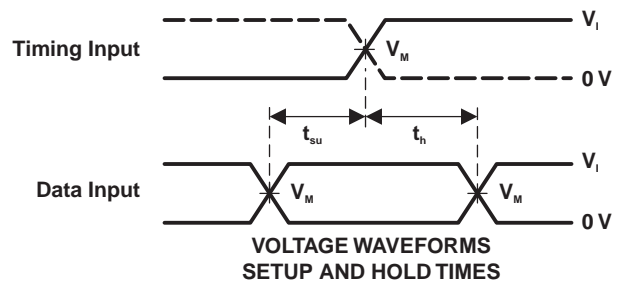
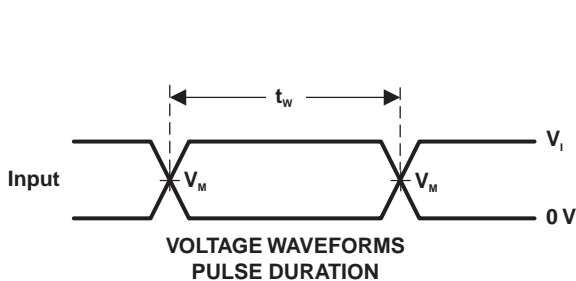

- NOTES:
- C_L includes probe and jig capacitance.
 - Waveform 1 is for an output with internal conditions such that the output is low, except when disabled by the output control. Waveform 2 is for an output with internal conditions such that the output is high, except when disabled by the output control.
 - All input pulses are supplied by generators having the following characteristics: $PRR \leq 10\text{ MHz}$, $Z_o = 50\ \Omega$.
 - The outputs are measured one at a time, with one transition per measurement.
 - Because this device has open-drain outputs, t_{PLZ} and t_{PZL} are the same as t_{PD} .
 - t_{PZL} is measured at V_M .
 - t_{PLZ} is measured at $V_{OL} + V_{\Delta}$.
 - All parameters and waveforms are not applicable to all devices.

Figure 3. Load Circuit and Voltage Waveforms (Open Drain)

8 Detailed Description

8.1 Overview

The SN74LVC2G06 dual open-drain inverter device contains one open-drain inverter with a maximum sink current of 32 mA. This device is fully specified for partial-power-down applications using I_{off} . The I_{off} circuitry disables the outputs, preventing damaging current backflow through the device when it is powered down.

8.2 Functional Block Diagram

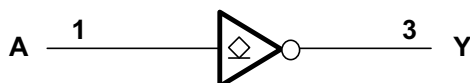

8.3 Feature Description

The wide operating voltage range of 1.65 V to 5.5 V allows the SN74LVC2G06 to be used in systems with many different voltage rails. In addition, the voltage tolerance on the output allows the device to be used for inverting up-translation or down-translation. The I_{OFF} feature safely allows voltage on the inputs and outputs when there's no V_{CC} is present.

8.4 Device Functional Modes

Table 1 lists the functional modes of the SN74LVC2G06.

Table 1. Function Table

INPUT A	OUTPUT Y
L	Hi-Z
H	L

9 Application and Implementation

NOTE

Information in the following applications sections is not part of the TI component specification and TI does not warrant its accuracy or completeness. TI's customers are responsible for determining suitability of components for their purposes. Customers should validate and test their design implementation to confirm system functionality.

9.1 Application Information

The SN74LVC2G06 is a dual high-drive CMOS device that implements a high-output drive buffer, such as an LED application. This device can sink 32 mA of current at 4.5 V making it ideal for high-drive applications and high-speed applications up to 100 MHz. The inputs are 5.5-V tolerant and let it to translate up or down to V_{CC} . The following [Typical Application](#) shows a simple LED driver application for a single channel of the device.

9.2 Typical Application

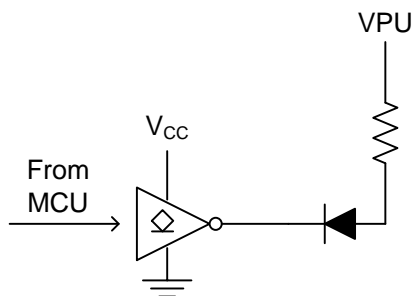

Figure 4. Typical Application Diagram

9.2.1 Design Requirements

This device uses CMOS technology and has balanced output drive. Avoid bus contention because it can drive currents that exceed maximum limits. The high drive also creates fast edges into light loads. Consider routing and load conditions to prevent ringing.

9.2.2 Detailed Design Procedure

1. Recommended Input Conditions
 - Rise time and fall time specs. See ($\Delta t/\Delta V$) in the [Recommended Operating Conditions](#) table.
 - Specified high and low levels. See (V_{IH} and V_{IL}) in the [Recommended Operating Conditions](#) table.
 - Inputs are overvoltage tolerant allowing them to go as high as (V_I max) in the [Recommended Operating Conditions](#) table at any valid V_{CC} .
2. Recommend Output Conditions
 - Load currents should not exceed (I_O max) per output and should not exceed (Continuous current through V_{CC} or GND) total current for the part. These limits are located in [Absolute Maximum Ratings](#) table.
 - Do not pull outputs above 5.5 V.

Typical Application (continued)

9.2.3 Application Curve

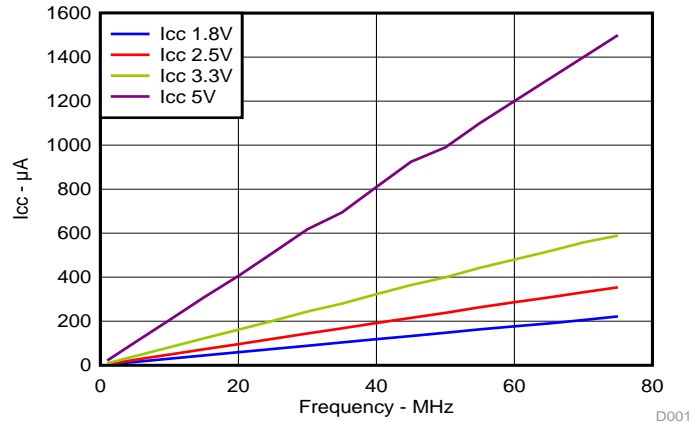

Figure 5. I_{CC} vs Frequency

10 Power Supply Recommendations

The power supply can be any voltage between the min and max supply voltage rating located in the [Recommended Operating Conditions](#) table.

Each V_{CC} pin must have a good bypass capacitor in order to prevent power disturbance. For devices with a single supply, a 0.1- μF capacitor is recommended and if there are multiple V_{CC} pins then a 0.01- μF or 0.022- μF capacitor is recommended for each power pin. It is ok to parallel multiple bypass caps to reject different frequencies of noise. 0.1- μF and 1- μF capacitors are commonly used in parallel. The bypass capacitor should be installed as close to the power pin as possible for best results.

11 Layout

11.1 Layout Guidelines

When using multiple bit logic devices, inputs must never float. In many cases, functions or parts of functions of digital logic devices are unused. Examples include when only two inputs of a triple input and gate are used or when only three of the four buffer gates are used. Avoid leaving input pins unconnected because the undefined voltages at the outside connections result in undefined operational states. Observe the following rules under all circumstances. Connect all unused inputs of digital logic devices to a high or low bias to prevent them from floating. Based on the function of the device, apply the logic level to any unused input. Based on convenience, tie unused inputs to the GND or the V_{CC}.

11.2 Layout Example

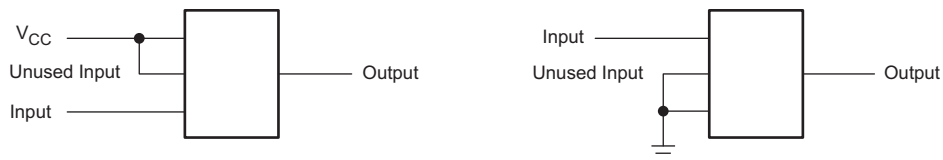

Figure 6. Layout Recommendation

12 Device and Documentation Support

12.1 Community Resources

The following links connect to TI community resources. Linked contents are provided "AS IS" by the respective contributors. They do not constitute TI specifications and do not necessarily reflect TI's views; see TI's [Terms of Use](#).

TI E2E™ Online Community *TI's Engineer-to-Engineer (E2E) Community*. Created to foster collaboration among engineers. At e2e.ti.com, you can ask questions, share knowledge, explore ideas and help solve problems with fellow engineers.

Design Support *TI's Design Support* Quickly find helpful E2E forums along with design support tools and contact information for technical support.

12.2 Trademarks

NanoFree, E2E are trademarks of Texas Instruments.
All other trademarks are the property of their respective owners.

12.3 Electrostatic Discharge Caution



These devices have limited built-in ESD protection. The leads should be shorted together or the device placed in conductive foam during storage or handling to prevent electrostatic damage to the MOS gates.

12.4 Glossary

[SLYZ022](#) — *TI Glossary*.

This glossary lists and explains terms, acronyms, and definitions.

13 Mechanical, Packaging, and Orderable Information

The following pages include mechanical, packaging, and orderable information. This information is the most current data available for the designated devices. This data is subject to change without notice and revision of this document. For browser-based versions of this data sheet, refer to the left-hand navigation.

PACKAGING INFORMATION

Orderable Device	Status (1)	Package Type	Package Drawing	Pins	Package Qty	Eco Plan (2)	Lead/Ball Finish (6)	MSL Peak Temp (3)	Op Temp (°C)	Device Marking (4/5)	Samples
SN74LVC2G06DBVR	ACTIVE	SOT-23	DBV	6	3000	Green (RoHS & no Sb/Br)	NIPDAU	Level-1-260C-UNLIM	-40 to 125	(C065, C06R)	Samples
SN74LVC2G06DBVRE4	ACTIVE	SOT-23	DBV	6	3000	Green (RoHS & no Sb/Br)	NIPDAU	Level-1-260C-UNLIM	-40 to 125	(C065, C06R)	Samples
SN74LVC2G06DCKR	ACTIVE	SC70	DCK	6	3000	Green (RoHS & no Sb/Br)	NIPDAU SN	Level-1-260C-UNLIM	-40 to 125	(CT5, CTJ, CTR)	Samples
SN74LVC2G06DCKRE4	ACTIVE	SC70	DCK	6	3000	Green (RoHS & no Sb/Br)	NIPDAU	Level-1-260C-UNLIM	-40 to 125	CT5	Samples
SN74LVC2G06DCKRG4	ACTIVE	SC70	DCK	6	3000	Green (RoHS & no Sb/Br)	NIPDAU	Level-1-260C-UNLIM	-40 to 125	CT5	Samples
SN74LVC2G06DRYR	ACTIVE	SON	DRY	6	5000	Green (RoHS & no Sb/Br)	NIPDAU	Level-1-260C-UNLIM	-40 to 125	CT	Samples
SN74LVC2G06DSFR	ACTIVE	SON	DSF	6	5000	Green (RoHS & no Sb/Br)	NIPDAU	Level-1-260C-UNLIM	-40 to 125	CT	Samples
SN74LVC2G06YZPR	ACTIVE	DSBGA	YZP	6	3000	Green (RoHS & no Sb/Br)	SNAGCU	Level-1-260C-UNLIM	-40 to 85	(CT7, CTN)	Samples

(1) The marketing status values are defined as follows:

ACTIVE: Product device recommended for new designs.

LIFEBUY: TI has announced that the device will be discontinued, and a lifetime-buy period is in effect.

NRND: Not recommended for new designs. Device is in production to support existing customers, but TI does not recommend using this part in a new design.

PREVIEW: Device has been announced but is not in production. Samples may or may not be available.

OBSOLETE: TI has discontinued the production of the device.

(2) **RoHS:** TI defines "RoHS" to mean semiconductor products that are compliant with the current EU RoHS requirements for all 10 RoHS substances, including the requirement that RoHS substance do not exceed 0.1% by weight in homogeneous materials. Where designed to be soldered at high temperatures, "RoHS" products are suitable for use in specified lead-free processes. TI may reference these types of products as "Pb-Free".

RoHS Exempt: TI defines "RoHS Exempt" to mean products that contain lead but are compliant with EU RoHS pursuant to a specific EU RoHS exemption.

Green: TI defines "Green" to mean the content of Chlorine (Cl) and Bromine (Br) based flame retardants meet JS709B low halogen requirements of <=1000ppm threshold. Antimony trioxide based flame retardants must also meet the <=1000ppm threshold requirement.

(3) MSL, Peak Temp. - The Moisture Sensitivity Level rating according to the JEDEC industry standard classifications, and peak solder temperature.

(4) There may be additional marking, which relates to the logo, the lot trace code information, or the environmental category on the device.

(5) Multiple Device Markings will be inside parentheses. Only one Device Marking contained in parentheses and separated by a "-" will appear on a device. If a line is indented then it is a continuation of the previous line and the two combined represent the entire Device Marking for that device.

(6) Lead/Ball Finish - Orderable Devices may have multiple material finish options. Finish options are separated by a vertical ruled line. Lead/Ball Finish values may wrap to two lines if the finish value exceeds the maximum column width.

Important Information and Disclaimer:The information provided on this page represents TI's knowledge and belief as of the date that it is provided. TI bases its knowledge and belief on information provided by third parties, and makes no representation or warranty as to the accuracy of such information. Efforts are underway to better integrate information from third parties. TI has taken and continues to take reasonable steps to provide representative and accurate information but may not have conducted destructive testing or chemical analysis on incoming materials and chemicals. TI and TI suppliers consider certain information to be proprietary, and thus CAS numbers and other limited information may not be available for release.

In no event shall TI's liability arising out of such information exceed the total purchase price of the TI part(s) at issue in this document sold by TI to Customer on an annual basis.

OTHER QUALIFIED VERSIONS OF SN74LVC2G06 :

- Automotive: [SN74LVC2G06-Q1](#)
- Enhanced Product: [SN74LVC2G06-EP](#)

NOTE: Qualified Version Definitions:

- Automotive - Q100 devices qualified for high-reliability automotive applications targeting zero defects
- Enhanced Product - Supports Defense, Aerospace and Medical Applications

TAPE AND REEL INFORMATION

QUADRANT ASSIGNMENTS FOR PIN 1 ORIENTATION IN TAPE

*All dimensions are nominal

Device	Package Type	Package Drawing	Pins	SPQ	Reel Diameter (mm)	Reel Width W1 (mm)	A0 (mm)	B0 (mm)	K0 (mm)	P1 (mm)	W (mm)	Pin1 Quadrant
SN74LVC2G06DBVR	SOT-23	DBV	6	3000	178.0	9.2	3.3	3.23	1.55	4.0	8.0	Q3
SN74LVC2G06DBVR	SOT-23	DBV	6	3000	180.0	8.4	3.23	3.17	1.37	4.0	8.0	Q3
SN74LVC2G06DCKR	SC70	DCK	6	3000	178.0	9.0	2.4	2.5	1.2	4.0	8.0	Q3
SN74LVC2G06DCKR	SC70	DCK	6	3000	178.0	9.2	2.4	2.4	1.22	4.0	8.0	Q3
SN74LVC2G06DCKR	SC70	DCK	6	3000	180.0	8.4	2.41	2.41	1.2	4.0	8.0	Q3
SN74LVC2G06DCKRG4	SC70	DCK	6	3000	178.0	9.2	2.4	2.4	1.22	4.0	8.0	Q3
SN74LVC2G06DRYR	SON	DRY	6	5000	180.0	9.5	1.15	1.6	0.75	4.0	8.0	Q1
SN74LVC2G06DSFR	SON	DSF	6	5000	180.0	9.5	1.16	1.16	0.5	4.0	8.0	Q2
SN74LVC2G06YZPR	DSBGA	YZP	6	3000	178.0	9.2	1.02	1.52	0.63	4.0	8.0	Q1

TAPE AND REEL BOX DIMENSIONS

*All dimensions are nominal

Device	Package Type	Package Drawing	Pins	SPQ	Length (mm)	Width (mm)	Height (mm)
SN74LVC2G06DBVR	SOT-23	DBV	6	3000	180.0	180.0	18.0
SN74LVC2G06DBVR	SOT-23	DBV	6	3000	202.0	201.0	28.0
SN74LVC2G06DCKR	SC70	DCK	6	3000	180.0	180.0	18.0
SN74LVC2G06DCKR	SC70	DCK	6	3000	180.0	180.0	18.0
SN74LVC2G06DCKR	SC70	DCK	6	3000	202.0	201.0	28.0
SN74LVC2G06DCKRG4	SC70	DCK	6	3000	180.0	180.0	18.0
SN74LVC2G06DRYR	SON	DRY	6	5000	184.0	184.0	19.0
SN74LVC2G06DSFR	SON	DSF	6	5000	184.0	184.0	19.0
SN74LVC2G06YZPR	DSBGA	YZP	6	3000	220.0	220.0	35.0

GENERIC PACKAGE VIEW

DRY 6

USON - 0.6 mm max height

PLASTIC SMALL OUTLINE - NO LEAD



Images above are just a representation of the package family, actual package may vary.
Refer to the product data sheet for package details.

4207181/G

DRY0006A



PACKAGE OUTLINE

USON - 0.6 mm max height

PLASTIC SMALL OUTLINE - NO LEAD

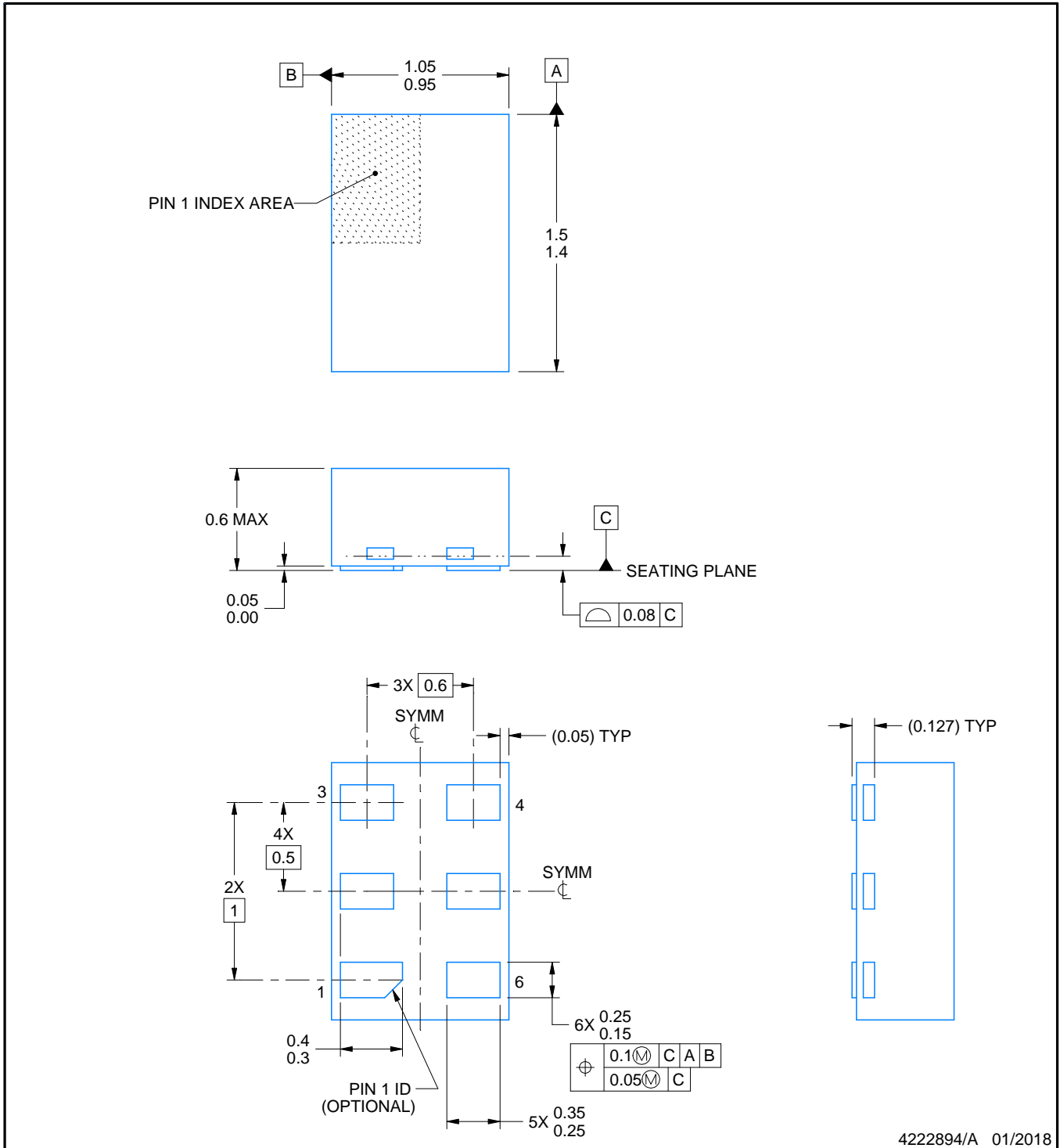

NOTES:

1. All linear dimensions are in millimeters. Any dimensions in parenthesis are for reference only. Dimensioning and tolerancing per ASME Y14.5M.
2. This drawing is subject to change without notice.

EXAMPLE BOARD LAYOUT

DRY0006A

USON - 0.6 mm max height

PLASTIC SMALL OUTLINE - NO LEAD



LAND PATTERN EXAMPLE
1:1 RATIO WITH PKG SOLDER PADS
EXPOSED METAL SHOWN
SCALE:40X



SOLDER MASK DETAILS

4222894/A 01/2018

NOTES: (continued)

3. For more information, see QFN/SON PCB application report in literature No. SLUA271 (www.ti.com/lit/slue271).

EXAMPLE STENCIL DESIGN

DRY0006A

USON - 0.6 mm max height

PLASTIC SMALL OUTLINE - NO LEAD



SOLDER PASTE EXAMPLE
BASED ON 0.075 - 0.1 mm THICK STENCIL
SCALE:40X

4222894/A 01/2018

NOTES: (continued)

4. Laser cutting apertures with trapezoidal walls and rounded corners may offer better paste release. IPC-7525 may have alternate design recommendations.

DBV0006A



PACKAGE OUTLINE

SOT-23 - 1.45 mm max height

SMALL OUTLINE TRANSISTOR

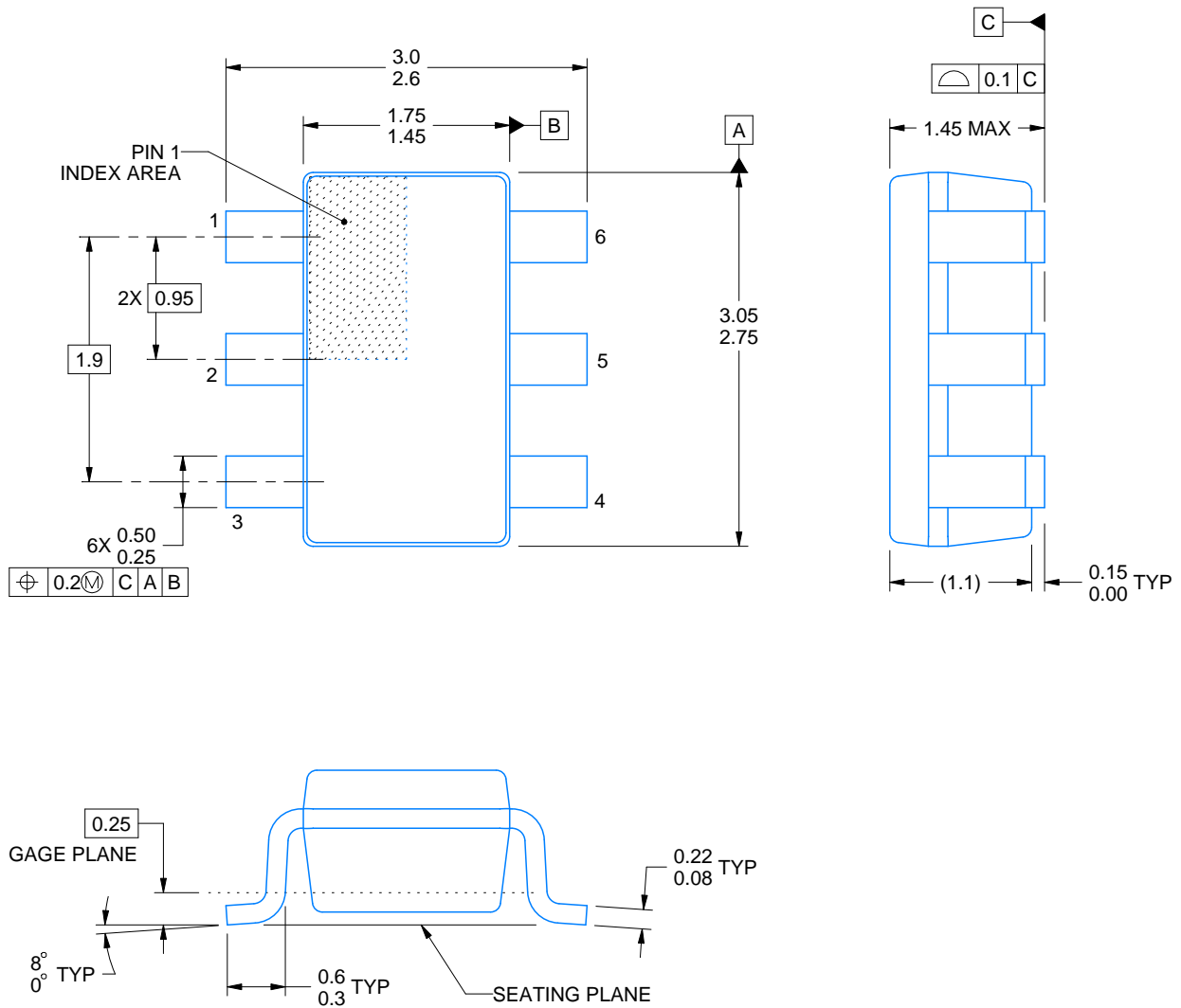

4214840/B 03/2018

NOTES:

1. All linear dimensions are in millimeters. Any dimensions in parenthesis are for reference only. Dimensioning and tolerancing per ASME Y14.5M.
2. This drawing is subject to change without notice.
3. Body dimensions do not include mold flash or protrusion. Mold flash and protrusion shall not exceed 0.15 per side.
4. Leads 1,2,3 may be wider than leads 4,5,6 for package orientation.
5. Reference JEDEC MO-178.

EXAMPLE BOARD LAYOUT

DBV0006A

SOT-23 - 1.45 mm max height

SMALL OUTLINE TRANSISTOR



LAND PATTERN EXAMPLE
EXPOSED METAL SHOWN
SCALE:15X

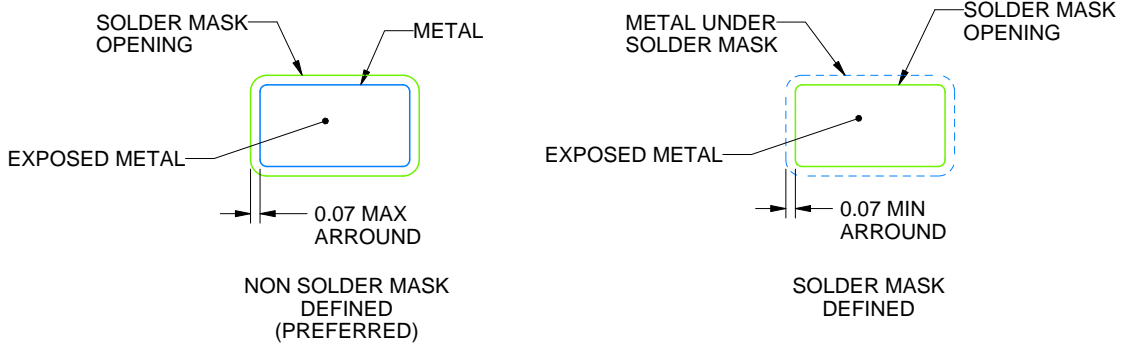

SOLDER MASK DETAILS

4214840/B 03/2018

NOTES: (continued)

6. Publication IPC-7351 may have alternate designs.

7. Solder mask tolerances between and around signal pads can vary based on board fabrication site.

EXAMPLE STENCIL DESIGN

DBV0006A

SOT-23 - 1.45 mm max height

SMALL OUTLINE TRANSISTOR



SOLDER PASTE EXAMPLE
BASED ON 0.125 mm THICK STENCIL
SCALE:15X

4214840/B 03/2018

NOTES: (continued)

8. Laser cutting apertures with trapezoidal walls and rounded corners may offer better paste release. IPC-7525 may have alternate design recommendations.
9. Board assembly site may have different recommendations for stencil design.

YZP0006

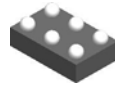

PACKAGE OUTLINE

DSBGA - 0.5 mm max height

DIE SIZE BALL GRID ARRAY

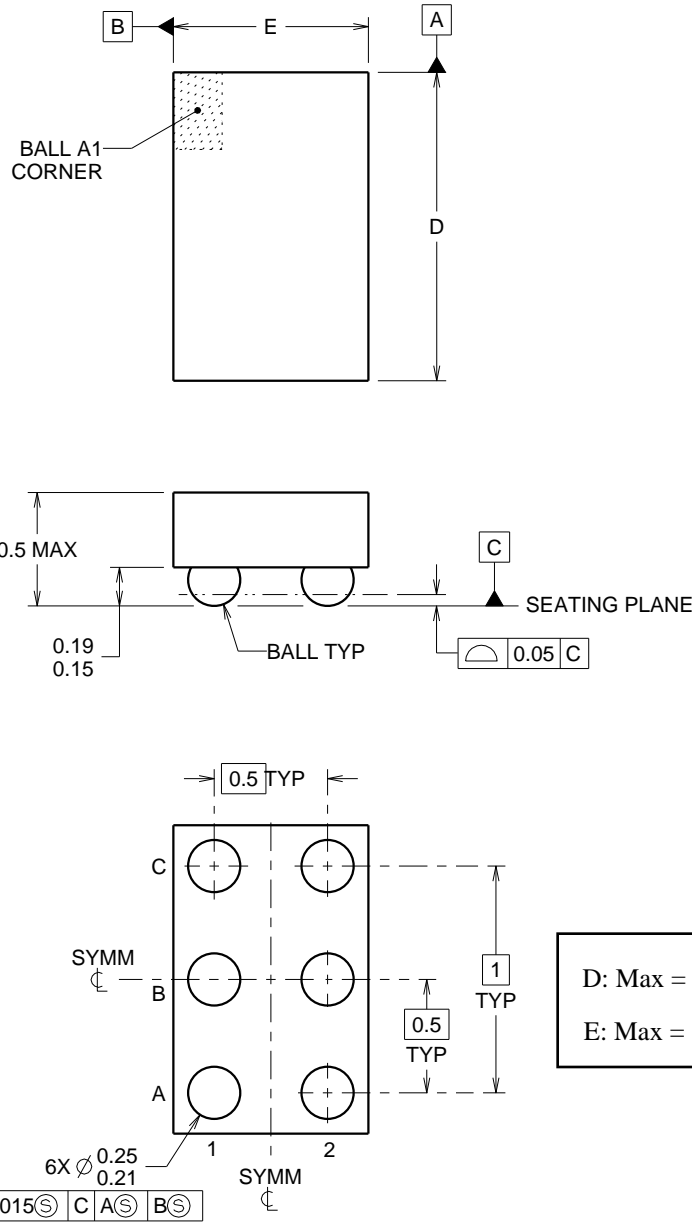

4219524/A 06/2014

NOTES:

NanoFree Is a trademark of Texas Instruments.

1. All linear dimensions are in millimeters. Any dimensions in parenthesis are for reference only. Dimensioning and tolerancing per ASME Y14.5M.
2. This drawing is subject to change without notice.
3. NanoFree™ package configuration.

EXAMPLE BOARD LAYOUT

YZP0006

DSBGA - 0.5 mm max height

DIE SIZE BALL GRID ARRAY



LAND PATTERN EXAMPLE
SCALE:40X

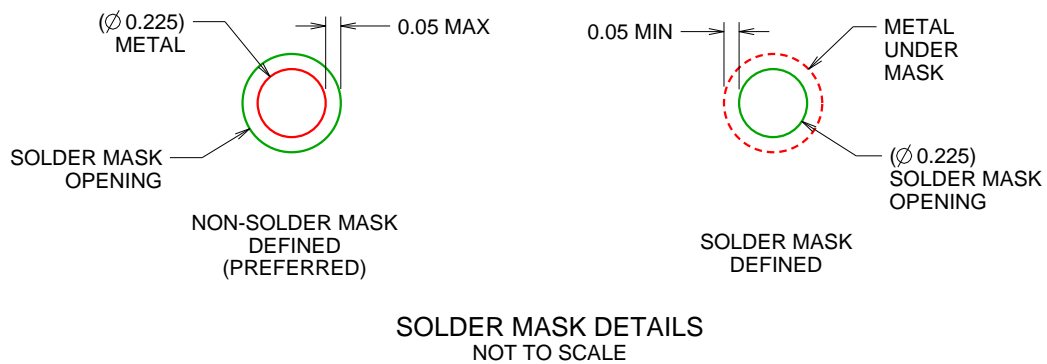

4219524/A 06/2014

NOTES: (continued)

- Final dimensions may vary due to manufacturing tolerance considerations and also routing constraints. For more information, see Texas Instruments literature number SBVA017 (www.ti.com/lit/sbva017).

EXAMPLE STENCIL DESIGN

YZP0006

DSBGA - 0.5 mm max height

DIE SIZE BALL GRID ARRAY

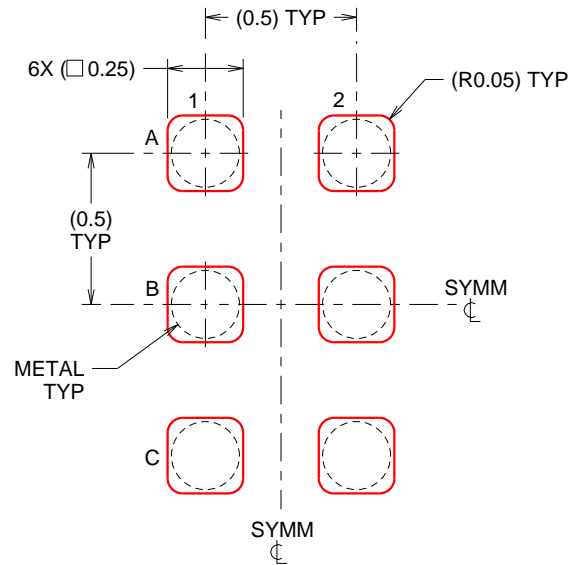

SOLDER PASTE EXAMPLE
BASED ON 0.1 mm THICK STENCIL
SCALE:40X

4219524/A 06/2014

NOTES: (continued)

5. Laser cutting apertures with trapezoidal walls and rounded corners may offer better paste release.



DSF0006A

PACKAGE OUTLINE

X2SON - 0.4 mm max height

PLASTIC SMALL OUTLINE - NO LEAD

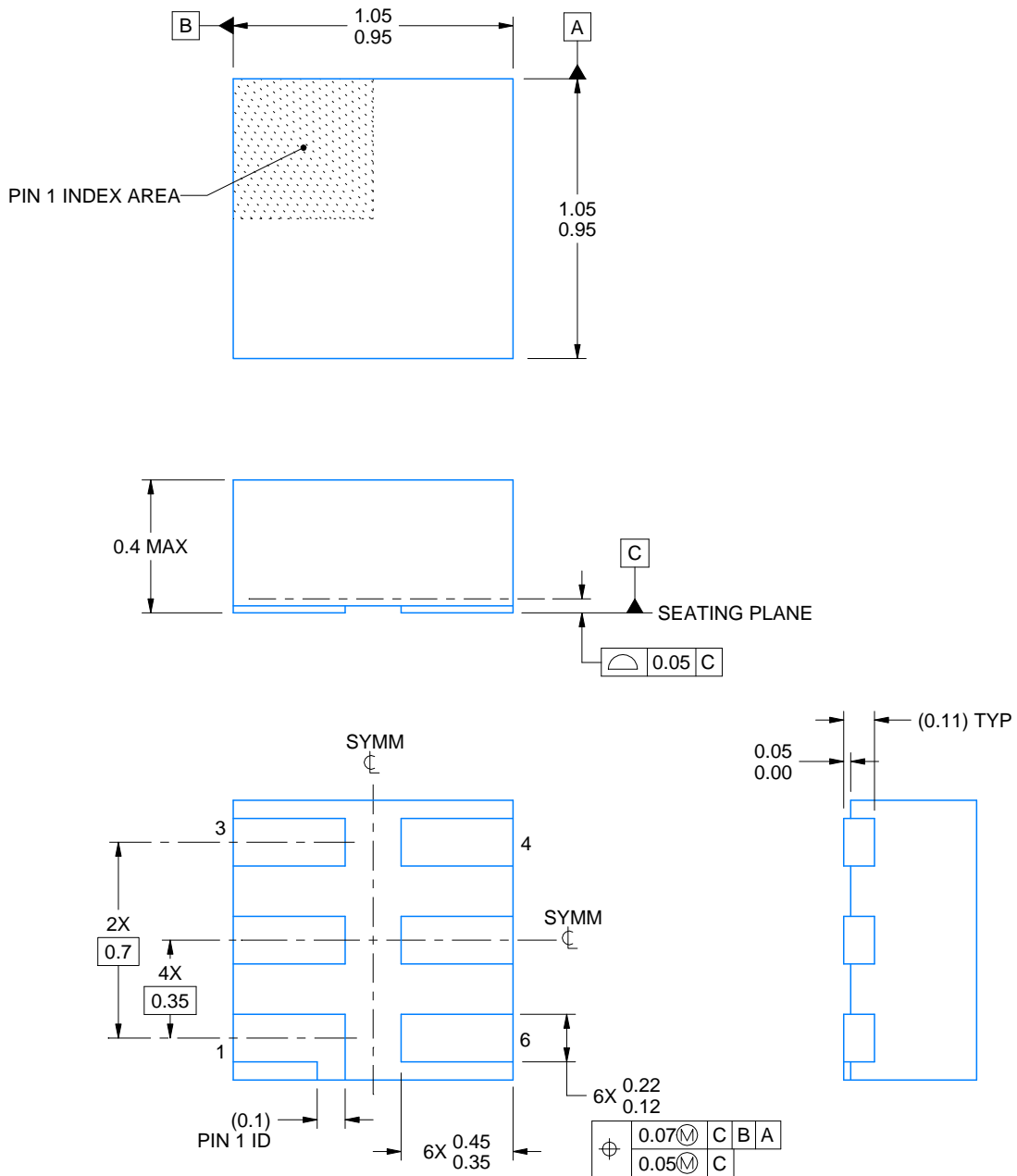

4220597/A 06/2017

NOTES:

1. All linear dimensions are in millimeters. Any dimensions in parenthesis are for reference only. Dimensioning and tolerancing per ASME Y14.5M.
2. This drawing is subject to change without notice.
3. Reference JEDEC registration MO-287, variation X2AAF.

EXAMPLE BOARD LAYOUT

DSF0006A

X2SON - 0.4 mm max height

PLASTIC SMALL OUTLINE - NO LEAD

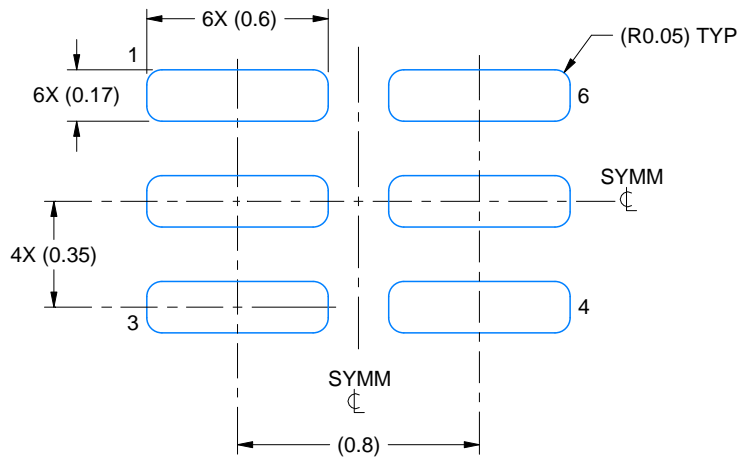

LAND PATTERN EXAMPLE
EXPOSED METAL SHOWN
SCALE:40X

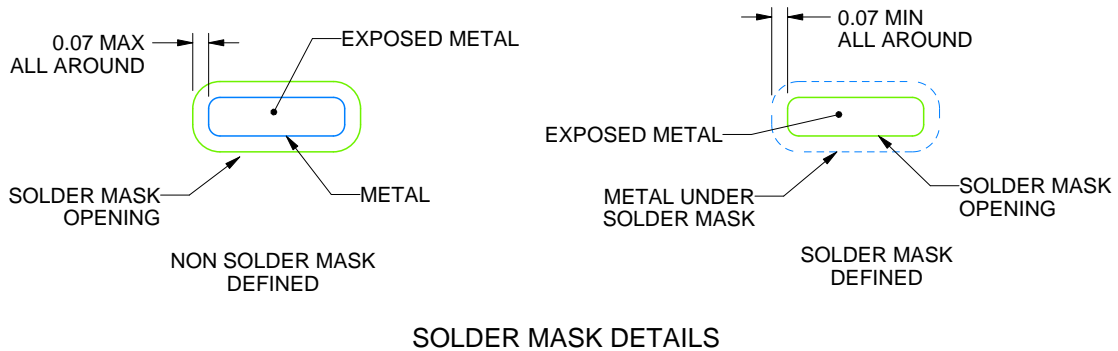

SOLDER MASK DETAILS

4220597/A 06/2017

NOTES: (continued)

4. For more information, see Texas Instruments literature number SLUA271 (www.ti.com/lit/slua271).

EXAMPLE STENCIL DESIGN

DSF0006A

X2SON - 0.4 mm max height

PLASTIC SMALL OUTLINE - NO LEAD

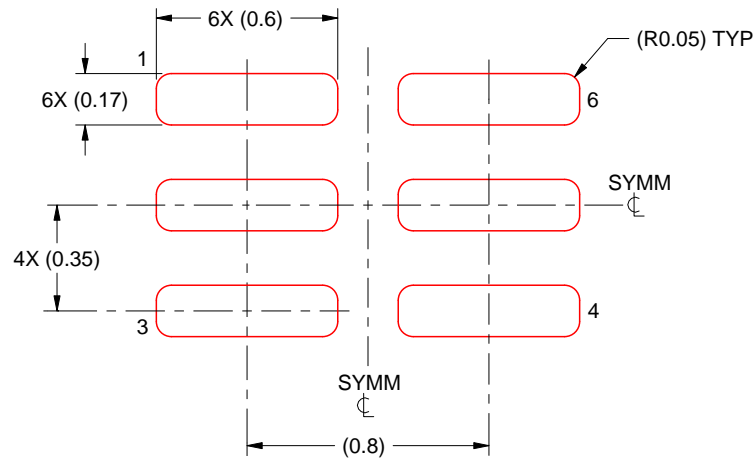

SOLDER PASTE EXAMPLE
BASED ON 0.125 mm THICK STENCIL
PRINTED SOLDER COVERAGE BY AREA UNDER PACKAGE
SCALE:40X

4220597/A 06/2017

4. Laser cutting apertures with trapezoidal walls and rounded corners may offer better paste release. IPC-7525 may have alternate design recommendations.

DCK (R-PDSO-G6)

PLASTIC SMALL-OUTLINE PACKAGE



- NOTES:
- A. All linear dimensions are in millimeters.
 - B. This drawing is subject to change without notice.
 - C. Body dimensions do not include mold flash or protrusion. Mold flash and protrusion shall not exceed 0.15 per side.
 - D. Falls within JEDEC MO-203 variation AB.

DCK (R-PDSO-G6)

PLASTIC SMALL OUTLINE

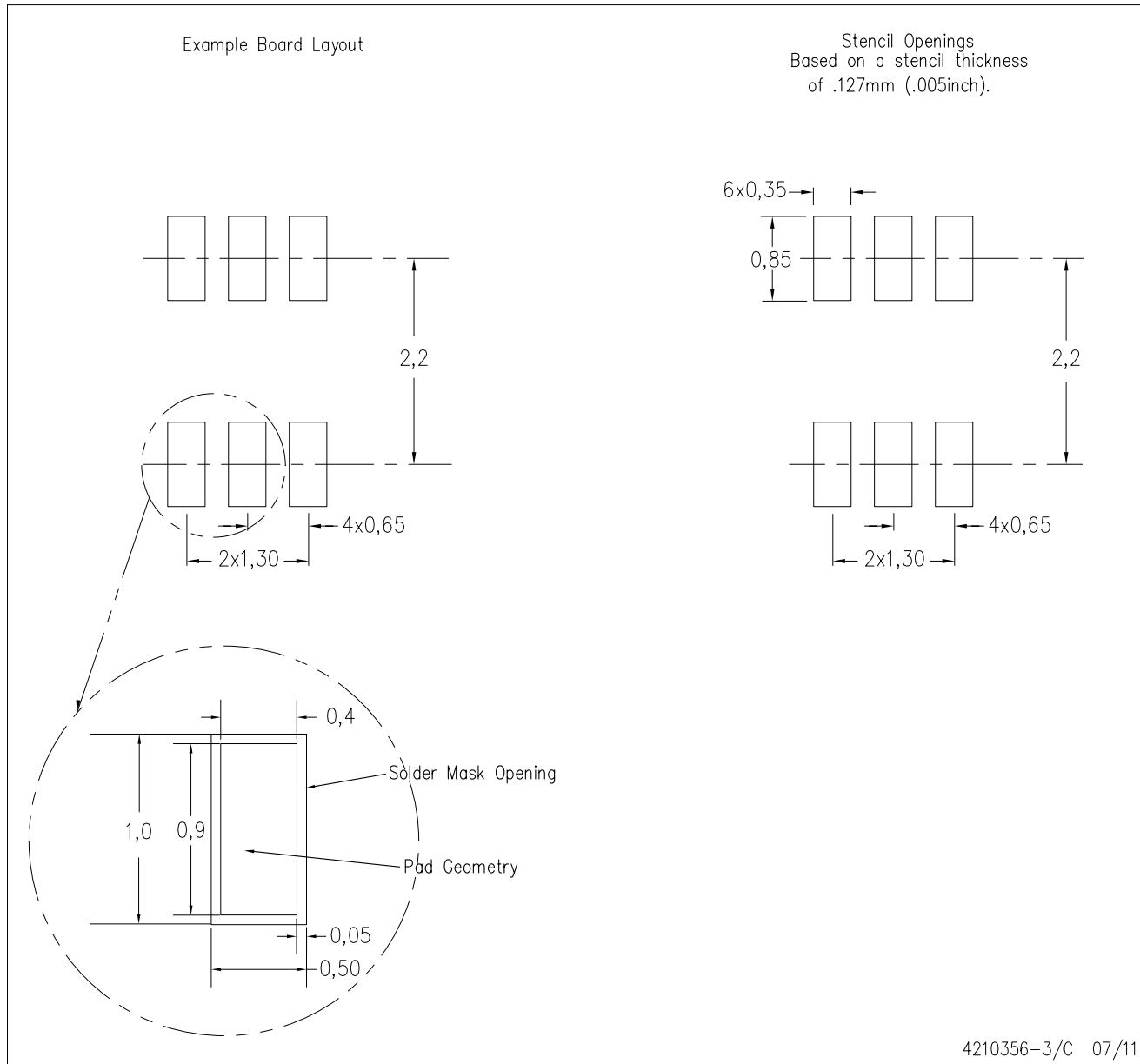

- NOTES:
- A. All linear dimensions are in millimeters.
 - B. This drawing is subject to change without notice.
 - C. Customers should place a note on the circuit board fabrication drawing not to alter the center solder mask defined pad.
 - D. Publication IPC-7351 is recommended for alternate designs.
 - E. Laser cutting apertures with trapezoidal walls and also rounding corners will offer better paste release. Customers should contact their board assembly site for stencil design recommendations. Example stencil design based on a 50% volumetric metal load solder paste. Refer to IPC-7525 for other stencil recommendations.

IMPORTANT NOTICE AND DISCLAIMER

TI PROVIDES TECHNICAL AND RELIABILITY DATA (INCLUDING DATASHEETS), DESIGN RESOURCES (INCLUDING REFERENCE DESIGNS), APPLICATION OR OTHER DESIGN ADVICE, WEB TOOLS, SAFETY INFORMATION, AND OTHER RESOURCES "AS IS" AND WITH ALL FAULTS, AND DISCLAIMS ALL WARRANTIES, EXPRESS AND IMPLIED, INCLUDING WITHOUT LIMITATION ANY IMPLIED WARRANTIES OF MERCHANTABILITY, FITNESS FOR A PARTICULAR PURPOSE OR NON-INFRINGEMENT OF THIRD PARTY INTELLECTUAL PROPERTY RIGHTS.

These resources are intended for skilled developers designing with TI products. You are solely responsible for (1) selecting the appropriate TI products for your application, (2) designing, validating and testing your application, and (3) ensuring your application meets applicable standards, and any other safety, security, or other requirements. These resources are subject to change without notice. TI grants you permission to use these resources only for development of an application that uses the TI products described in the resource. Other reproduction and display of these resources is prohibited. No license is granted to any other TI intellectual property right or to any third party intellectual property right. TI disclaims responsibility for, and you will fully indemnify TI and its representatives against, any claims, damages, costs, losses, and liabilities arising out of your use of these resources.

TI's products are provided subject to TI's Terms of Sale (www.ti.com/legal/termsofsale.html) or other applicable terms available either on ti.com or provided in conjunction with such TI products. TI's provision of these resources does not expand or otherwise alter TI's applicable warranties or warranty disclaimers for TI products.

Mailing Address: Texas Instruments, Post Office Box 655303, Dallas, Texas 75265
Copyright © 2020, Texas Instruments Incorporated